

TEKNIKUM®

Polyurethane wear plates

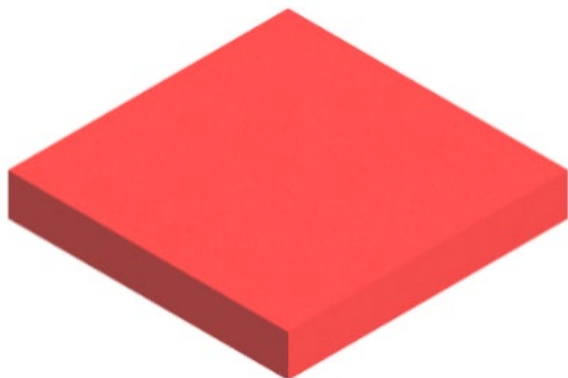

APPLICATIONS

Teknikum® Polyurethane wear plates are manufactured from extremely wear resistant polyurethane material. The plate provides also effective protection against noise and vibration. Suitable applications include material handling, feed and drain chutes, tunnels, feeders, and silos & several type of dry and wet material channels in the mining industry.

Minimum order quantity is 1 plate.

ADVANTAGES

- Easy installations with fixing system
- Suitable for wide range of applications
- Protects against impacts
- Low friction surface
- Effective noise and vibration isolation
- Compatible size selection
- Customized sizes available on request

TECHNICAL PROPERTIES

Structure

- Backing steel reinforcement or aluminum / steel fixing profiles for fastening and structural support.
- High-quality polyurethane compound
- Polyurethane hardness 70-90 ShA

Temperature range

- 40°C... +100°C

ENVIRONMENTAL RESISTANCE

- Wear-resistant
- Chemical resistant
- Oil-resistant
- Mechanical impact resistant

INSTALLATION

- Fixed bolts on wear plate:

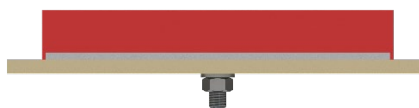

- Fixing profile with T-bolts:

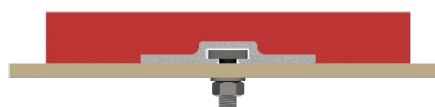

WEAR INDICATION

Visual wear indicator is available to monitor and schedule the need to renew wear plate. Please ask more information from our sales.

MANUFACTURER

Teknikum Oy (Business ID FI07645274),
Nokiankatu 1, 38210, Sastamala, Finland

More information

sales@teknikum.com

www.teknikum.com

All rights reserved. © 2020 Teknikum Group Ltd.



ORDER REFERENCE

Please contact Teknikum sales for customized dimension, fixing system or shape.

Product	Width mm	Lenght mm	Thickness mm	Steel re-enforcement	Fixing type
With fixed bolts on wear plate: Nut M12 nyloc DIN 985 / washer M12 DIN 125 A					
Other sizes / fixings size and patterns available on request.					
WPP-001-S	250	250	25	5	1 x M12 Bolt
WPP-002-S	250	500	25	5	2x M12 Bolt
WPP-003-S	500	500	25	5	4 x M12 Bolt
WPP-004-S	250	250	35	5	1 x M12 Bolt
WPP-005-S	250	500	35	5	2 x M12 Bolt
WPP-006-S	500	500	35	5	4x M12 Bolt
WPP-007-S	250	250	75	5	1 x M12 Bolt
WPP-008-S	250	500	75	5	2 x M12 Bolt
WPP-009-S	500	500	75	5	4 x M12 Bolt
With fixing profile: T-bolt M12 / Nut M12 nyloc DIN 985 / washer M12 DIN 125 A					
Other sizes / fixings profile sizes available on request.					
WPP-001-P	250	250	35	15x120	1 set / profile
WPP-002-P	250	500	35	15x120	2 sets / profile
WPP-003-P	500	500	35	15x120	4 sets / profile
WPP-004-P	250	250	75	15x120	1 set / profile
WPP-005-P	250	500	75	15x120	2 sets / profile
WPP-006-P	500	500	75	15x120	4 sets / profile

REFERENCE IMAGES: **FIXED BOLTS**

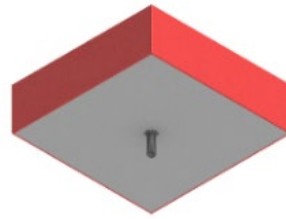
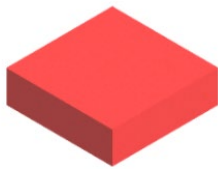

W250mm x L250mm (Thickness 25 ,35, 75mm)

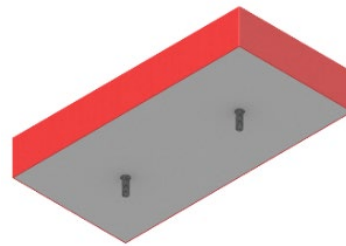
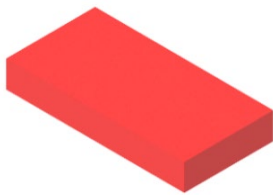

W250mm x L500mm (Thickness 25, 35, 75mm)

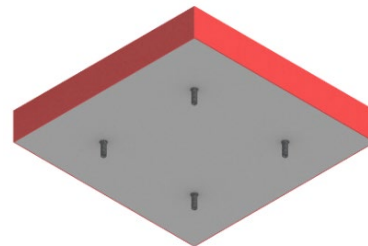
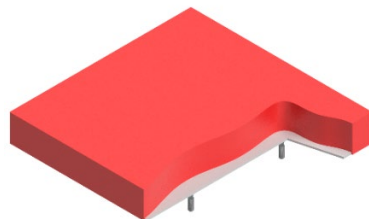
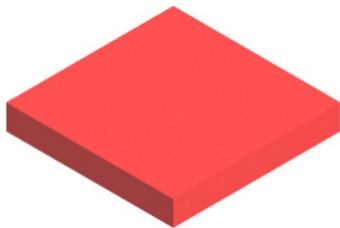

W500mm x L500mm (Thickness 25, 35, 75mm)

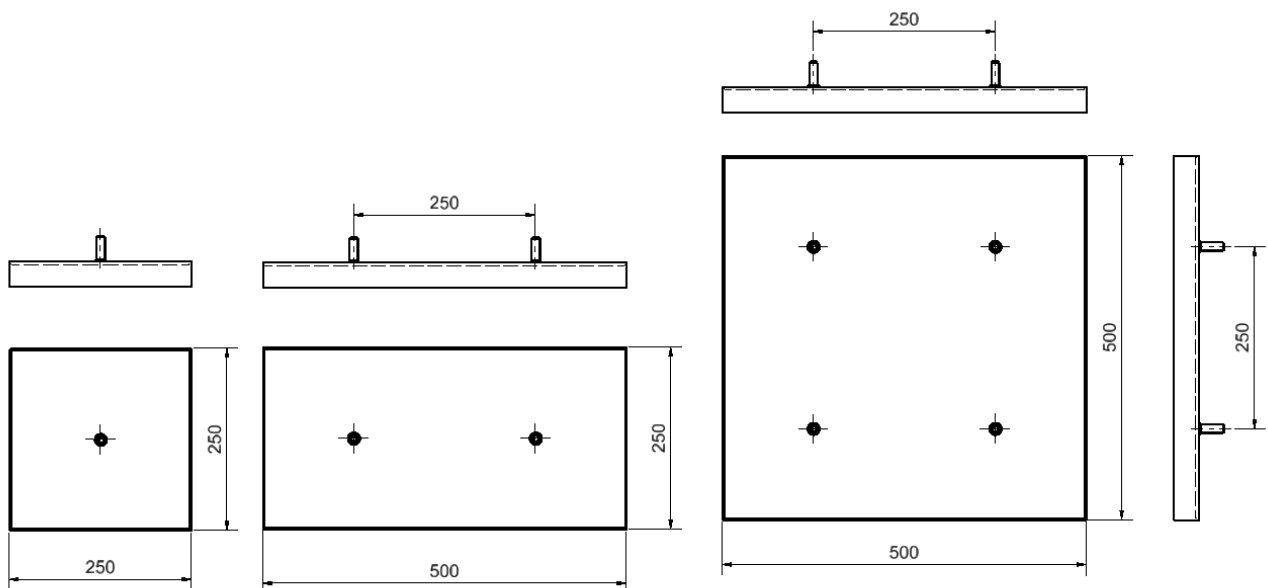

REFERENCE IMAGES: FIXING PROFILE

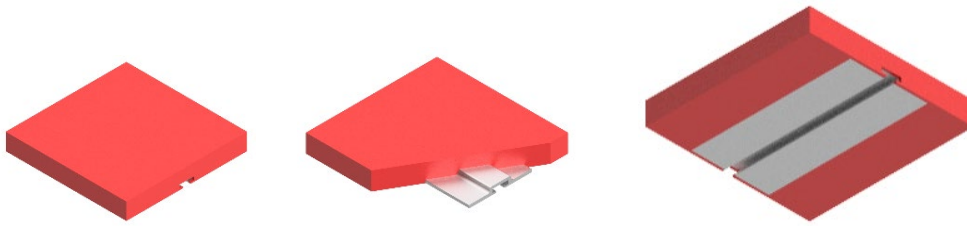

W250mm x L250mm (Thickness 35, 75mm)

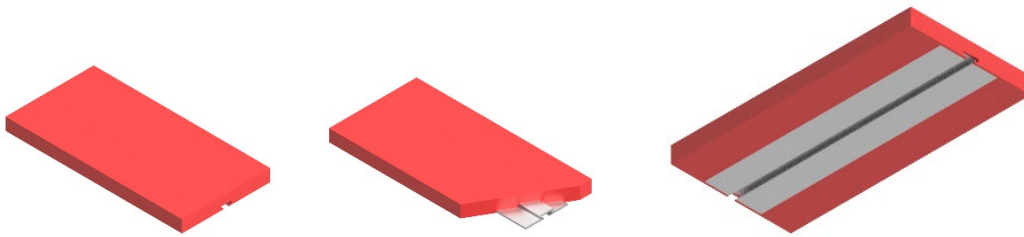

W250mm x L500mm (Thickness 35, 75mm)

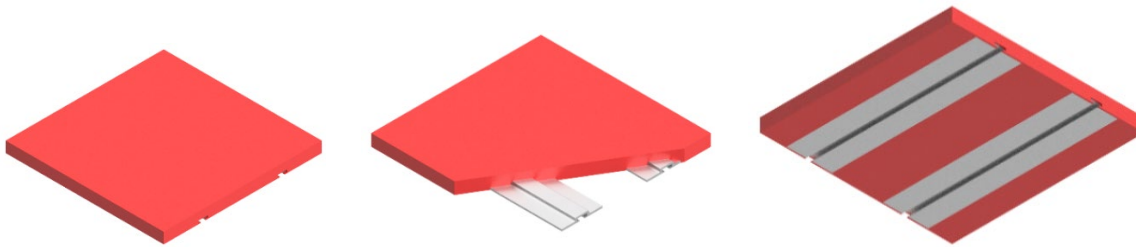

W500mm x L500mm (Thickness 35, 75mm)

