

TEKNIKUM®

Ceramic wear plates

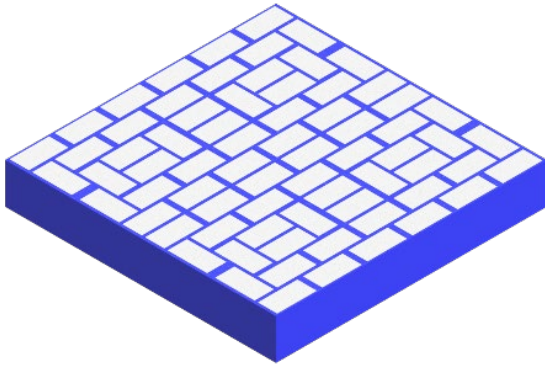

APPLICATIONS

Teknikum® Ceramic wear plate is made of material combination with unique advantages against impact and high abrasion wear of wet and dry materials.

Suitable applications include material handling, feed and drain chutes, tunnels, feeders, and silos & several type of dry and wet material channels in the mining industry.

Standard element sizes and custom options are available with fast delivery.

Minimum order quantity is 1 plate.

ADVANTAGES

- Easy installations with fixing system
- Suitable for wide range of applications
- Protective surface against abrasion
- Extended service life
- Low friction surface
- Effective against noise and vibration
- Compatible size selection
- Customized sizes and fixing available on request

TECHNICAL PROPERTIES

Structure

- Teknikum uses only high-quality ceramics -based on internal quality requirements and long-term experience of wear plates in extremely heavy circumstances.
- Backing steel plate or aluminum fixing profile enables for fastening and structural support.
- Structure material's hardness is 50-90 ShA

Temperature range

- 40°C... +100°C

ENVIRONMENTAL RESISTANCE

- Wear-resistant
- Chemical resistant
- Oil resistant
- Mechanical impact resistant

INSTALLATION OPTIONS

- Fixed bolts (35mm or 75mm) on steel back wear plate:

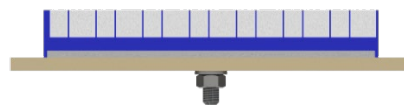

- Fixing profile (35mm or 75mm) with T-bolts:

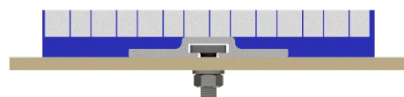

WEAR INDICATION

Visual wear indicator is available to monitor and schedule the need to renew wear plate. Please ask more information from our sales.

More information

sales@teknikum.com

www.teknikum.com

All rights reserved. © 2020 Teknikum Group Ltd.

MANUFACTURER

Teknikum Oy (Business ID FI07645274),
Nokiankatu 1, 38210, Sastamala, Finland



ORDER REFERENCE

Different sizes are available. Please contact Teknikum sales for customized dimension, fixing system or shape.

Product code	Width mm	Lenght mm	Thickness mm	Steel re-enforcement mm	Ceramic thickness mm	Fixing type
With fixed bolts: Nut M12 nyloc DIN 985 /washer M12 DIN 125 A						
Other sizes / fixings size & patterns available on request.						
WPC-001-S	250	250	35	5	20	1 x M12 Bolt
WPC-002-S	250	500	35	5	20	2 x M12 Bolt
WPC-003-S	500	500	35	5	20	4 x M12 Bolt
WPC-004-S	250	250	75	5	50	1 x M12 Bolt
WPC-005-S	250	500	75	5	50	2 x M12 Bolt
WPC-006-S	500	500	75	5	50	4 x M12 Bolt
With fixing profile: T-bolt M12 /nut M12 nyloc DIN 985 /washer M12 DIN 125 A						
Other sizes / fixings size & patterns available on request.						
WPC-001-P	250	250	35	15x120	20	1 set / profile
WPC-002-P	250	500	35	15x120	20	2 sets / profile
WPC-003-P	500	500	35	15x120	20	4 sets / profile
WPC-004-P	250	250	75	15x120	50	1 set / profile
WPC-005-P	250	500	75	15x120	50	2 sets / profile
WPC-006-P	500	500	75	15x120	50	4 sets / profile

REFERENCE IMAGES: FIXED BOLTS 35mm

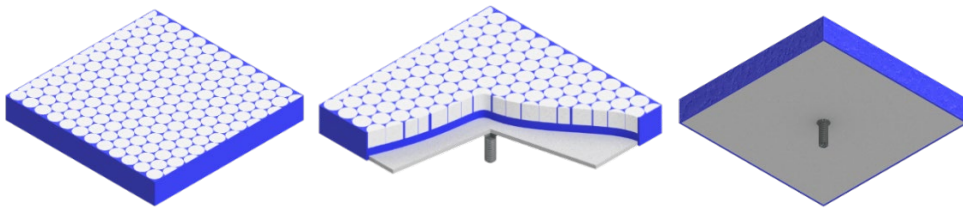

W250mm x L250mm (Thickness 35mm, ceramic thickness 20mm)

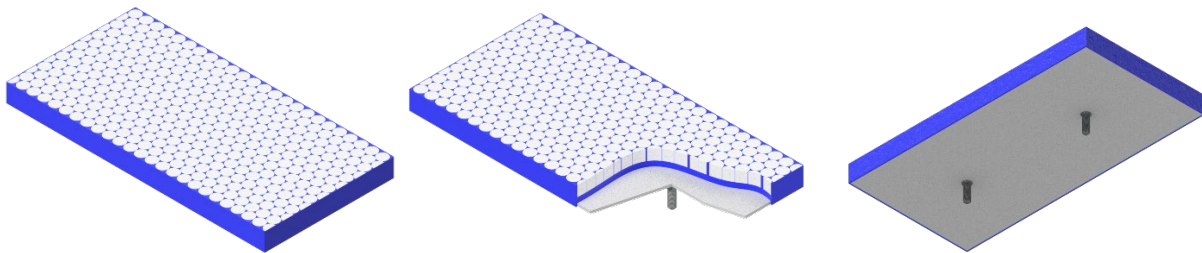

W250mm x L250mm (Thickness 35mm, ceramic thickness 20mm)

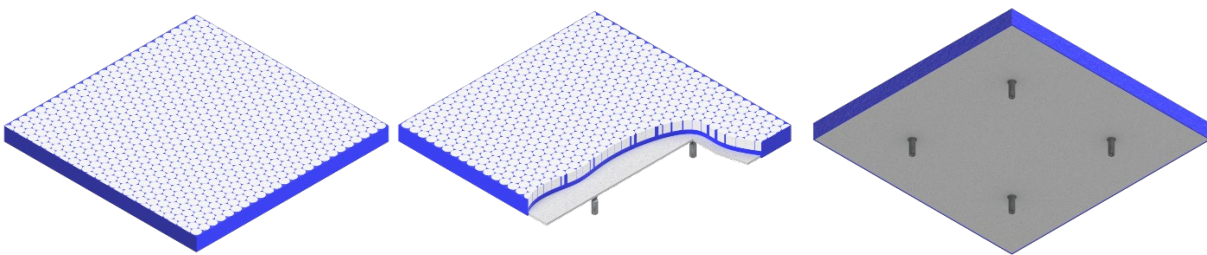

W500mm x L500mm (Thickness 35mm, ceramic thickness 20mm)

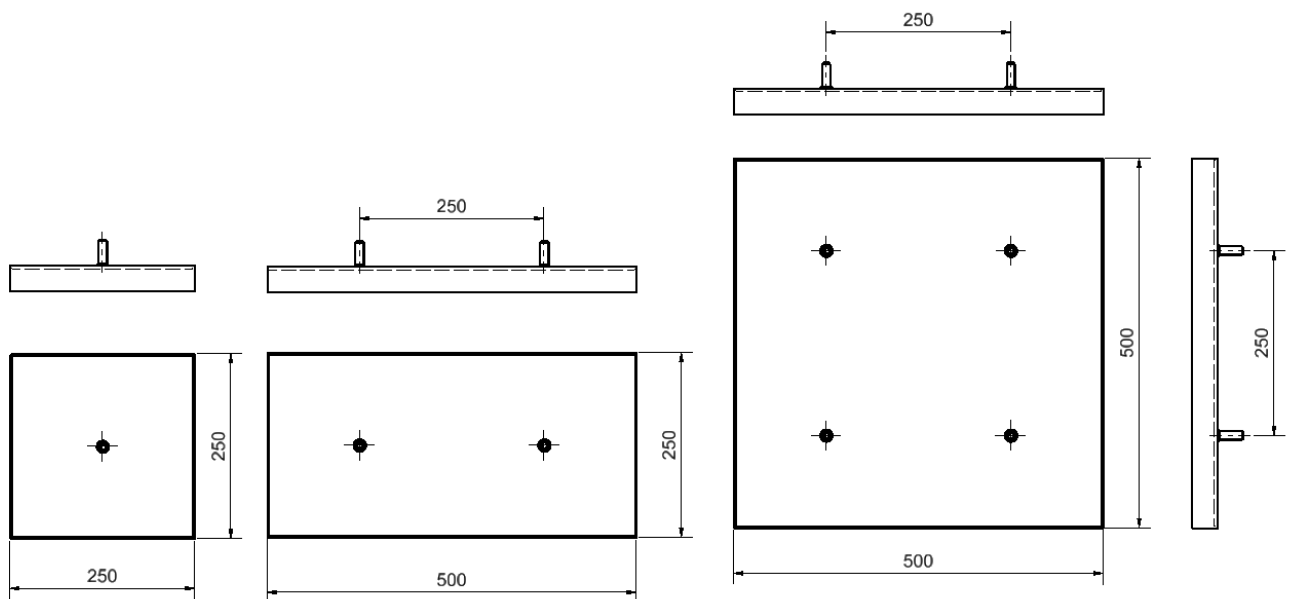

REFERENCE IMAGES: FIXED BOLTS **75mm**

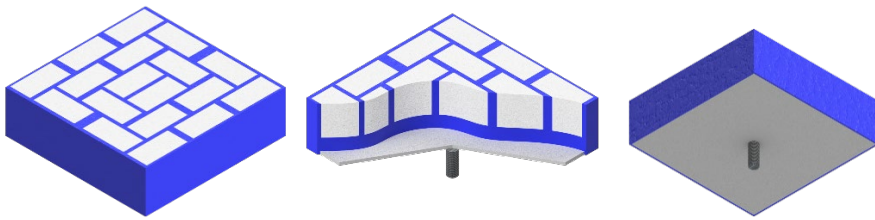

W250mm x L250mm (Thickness 75mm , ceramic thickness 50mm)

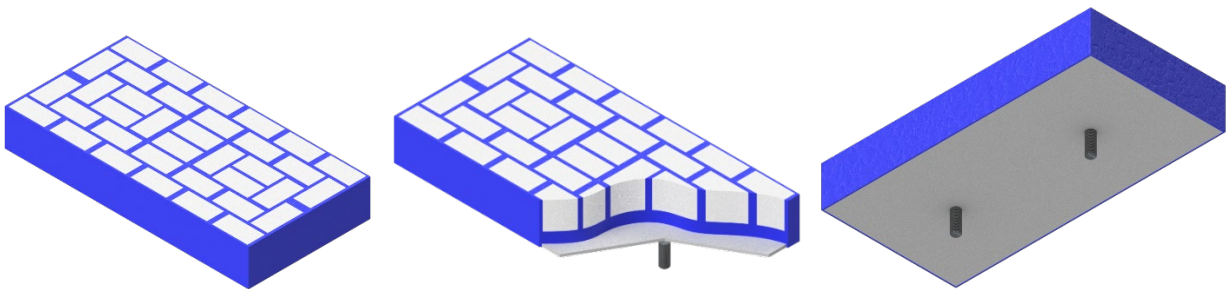

W250mm x L500mm (Thickness 75mm, ceramic thickness 50mm)

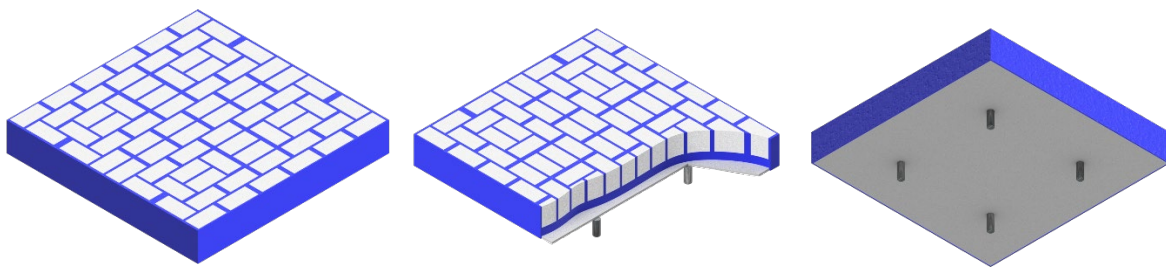

W500mm x L500mm (Thickness 75mm, ceramic thickness 50mm)

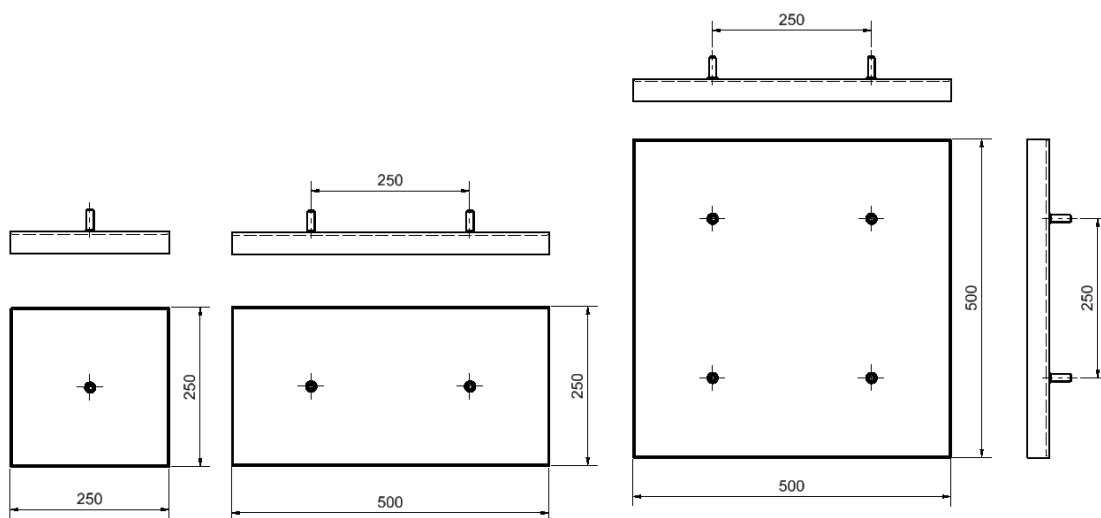

REFERENCE IMAGES: FIXING PROFILE **35mm**

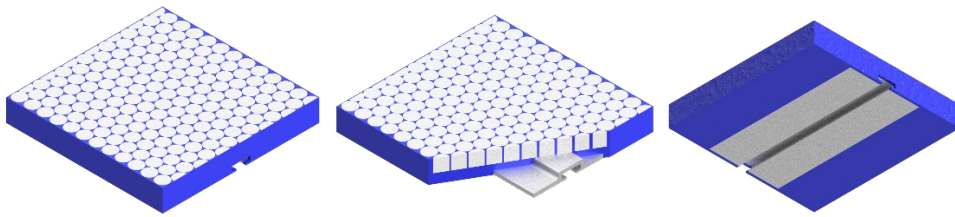

W250mm x L250mm (Thickness 35mm, ceramic thickness 20mm)

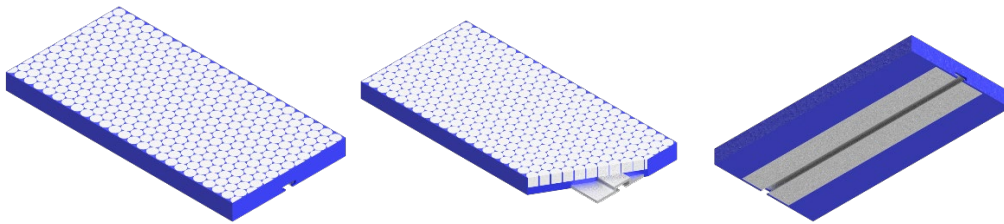

W250mm x L500mm (Thickness 35mm, ceramic thickness 20mm)

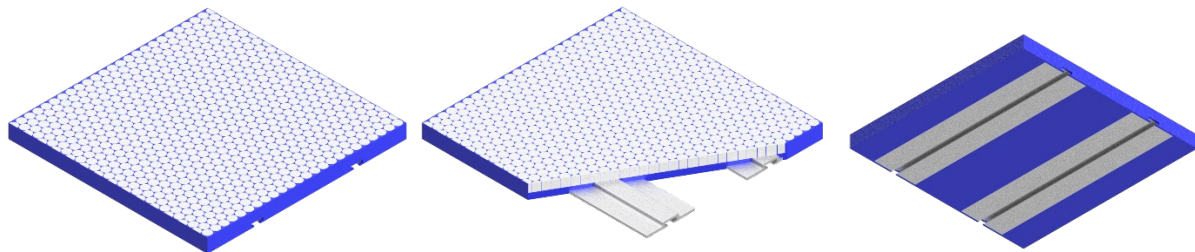

W500mm x L500mm (Thickness 35mm, ceramic thickness 20mm)

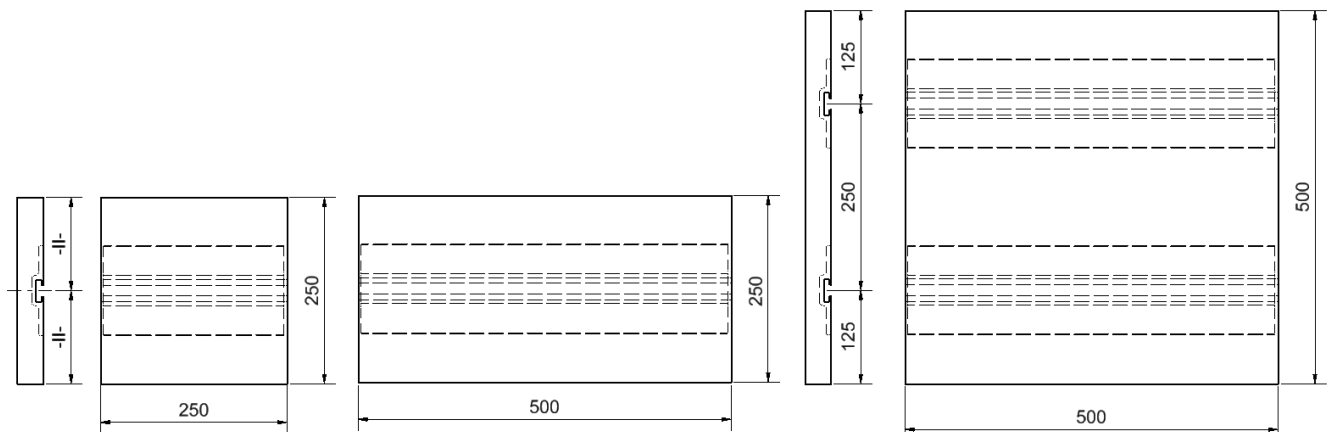

REFERENCE IMAGES: FIXING PROFILE **75mm**

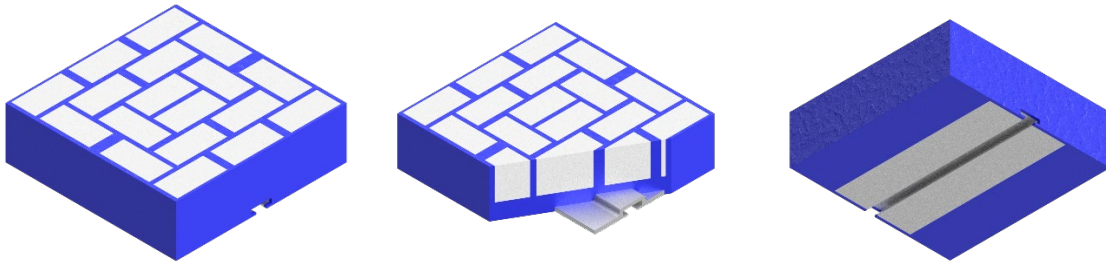

W250mm x L250mm (Thickness 75mm, ceramic thickness 50mm)

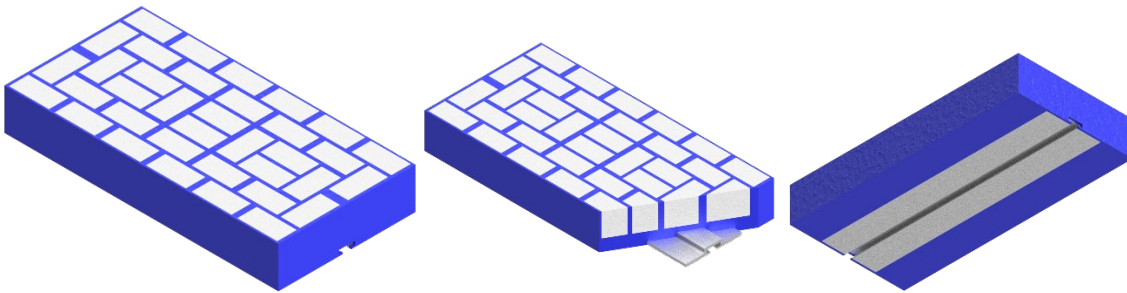

W250mm x L500mm (Thickness 75mm, ceramic thickness 50mm)

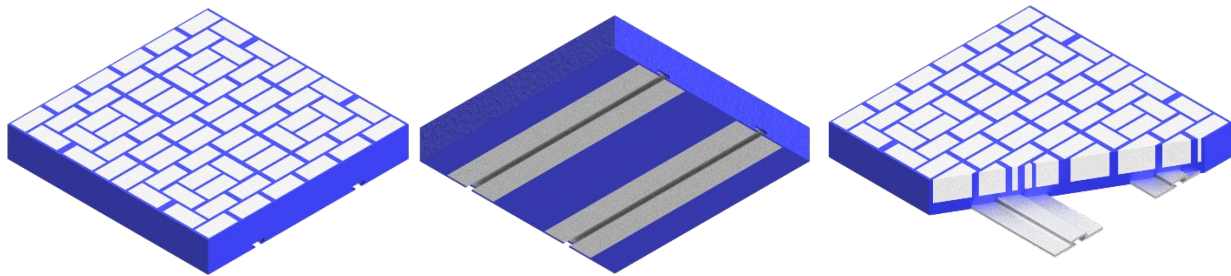

W500mm x L500mm (Thickness 75mm, ceramic thickness 50mm)

